

INGENIO

Installation
PLAQUE DE COMMANDE



SIAMP
Monaco



www.siamp.fr/ingenio

INSTALLATION PLAQUE DE COMMANDE

1

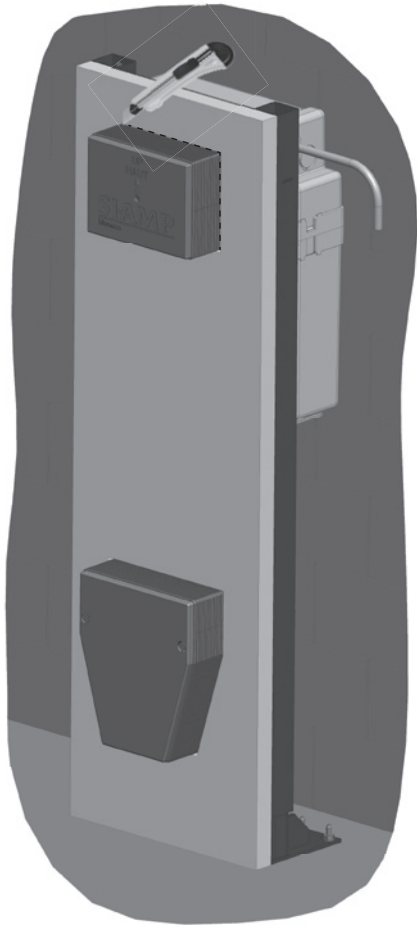

2

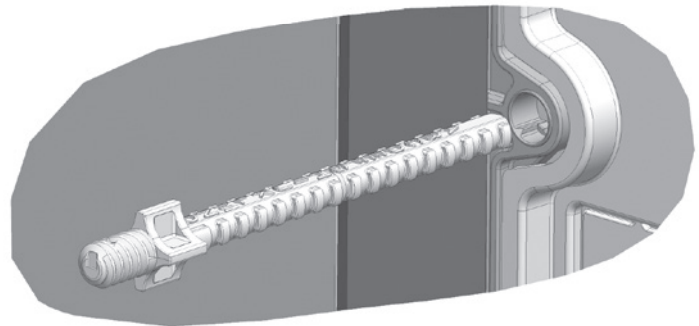
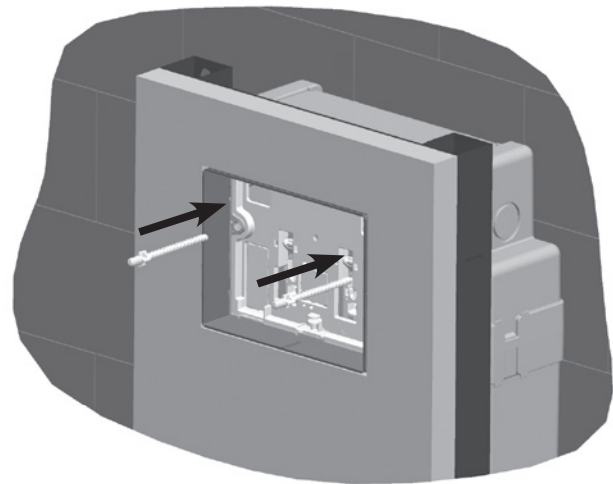

INSTALLATION PLAQUE DE COMMANDE

3

Une fois le gabarit découpé, la lettre la plus proche de vous est la première qui doit être visible lors de l'insertion des tiges de fixation sur le réservoir, dans l'exemple ci-contre "L".

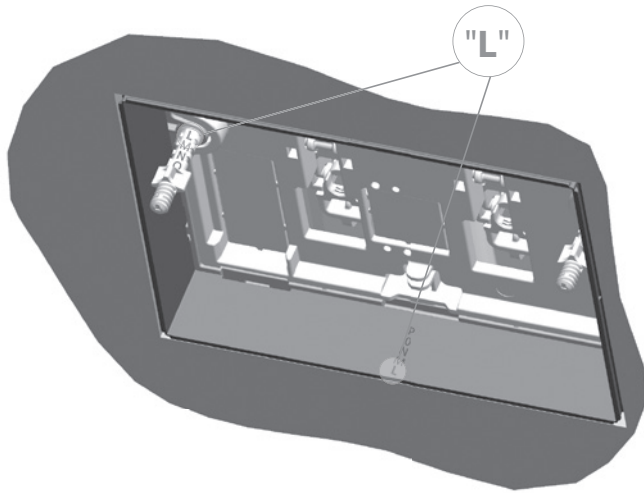

4

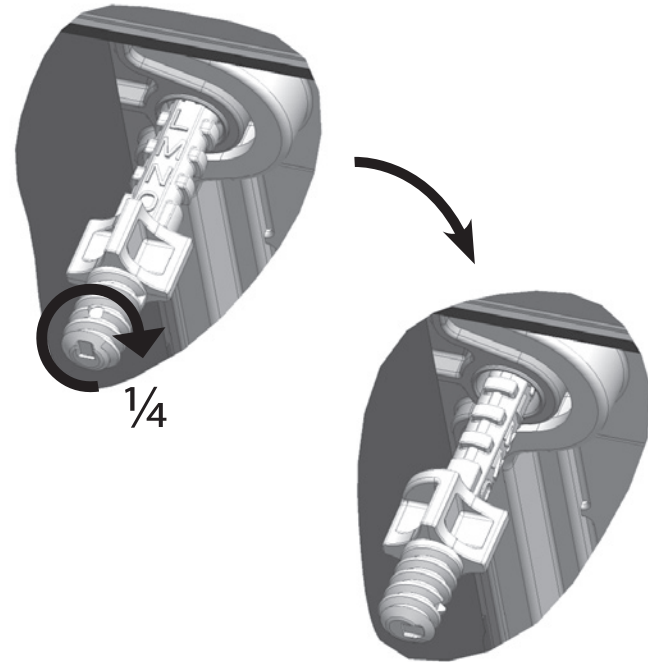

INSTALLATION PLAQUE DE COMMANDE

5

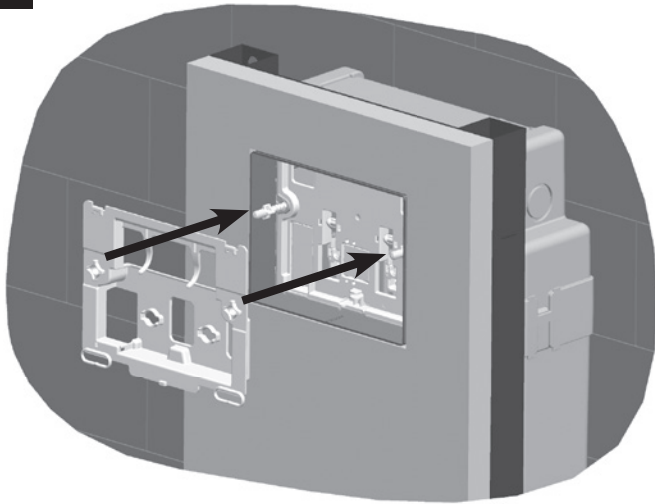

6

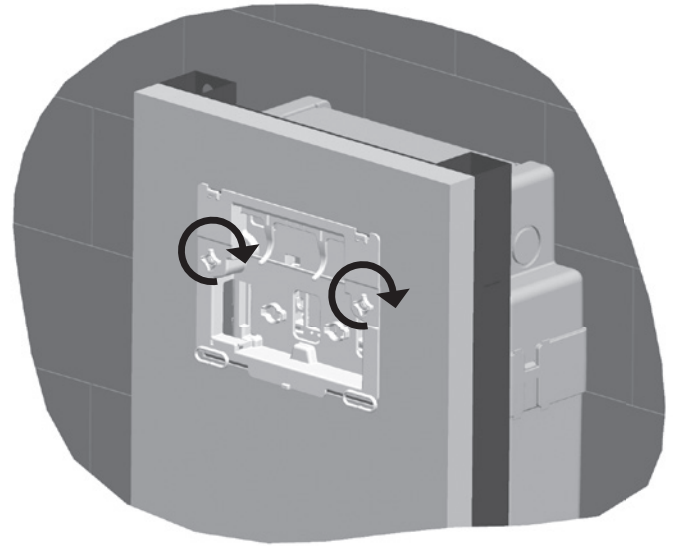

INSTALLATION PLAQUE DE COMMANDE

7

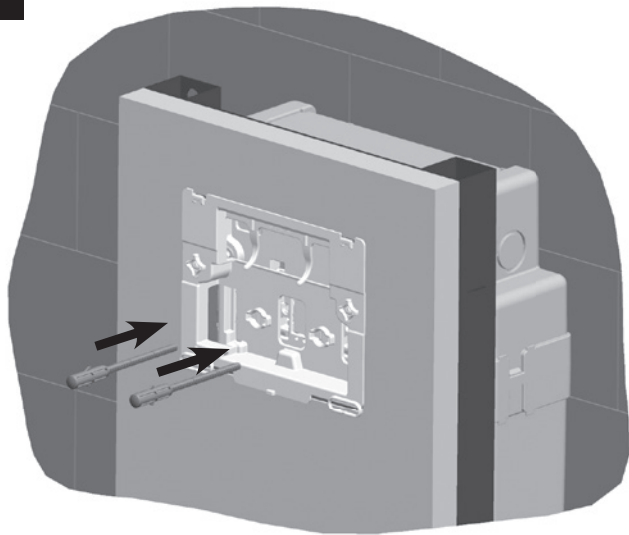

8

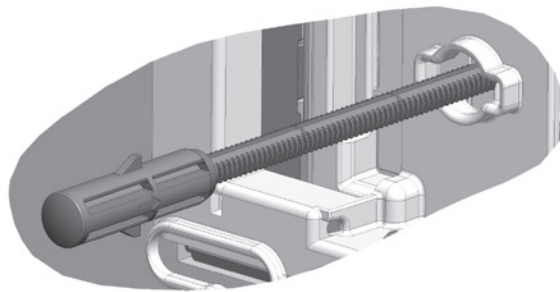

INSTALLATION PLAQUE DE COMMANDE

9

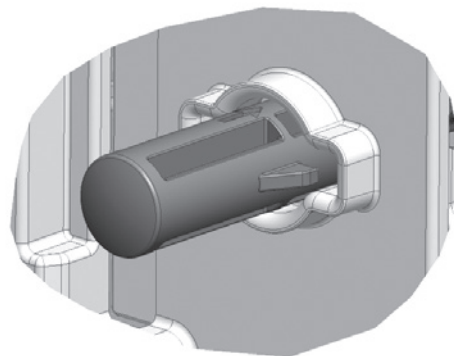
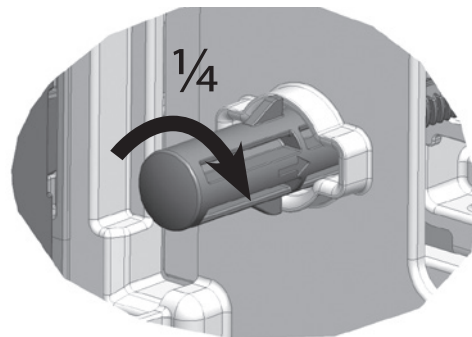
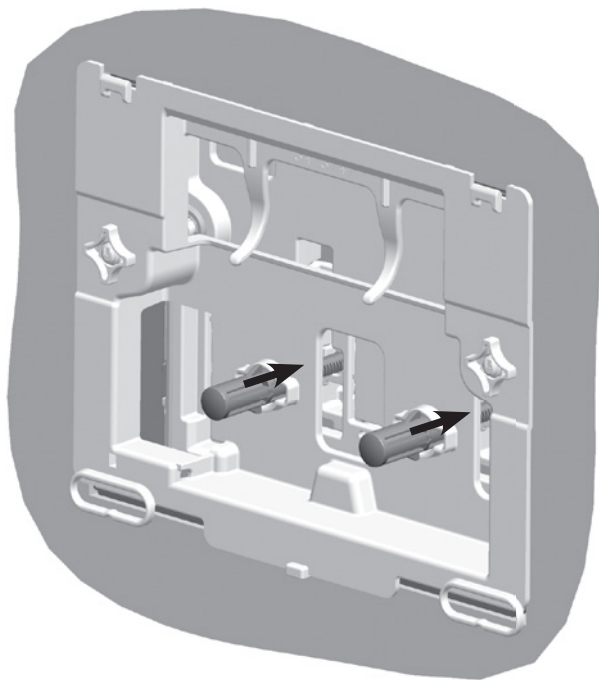

INSTALLATION PLAQUE DE COMMANDE

10

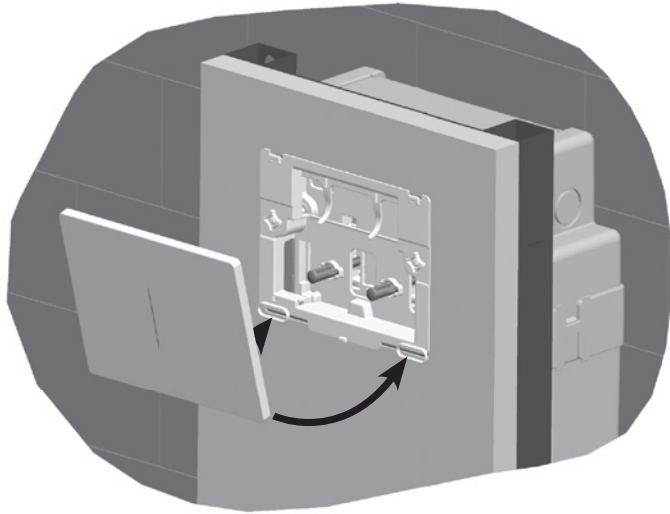

11

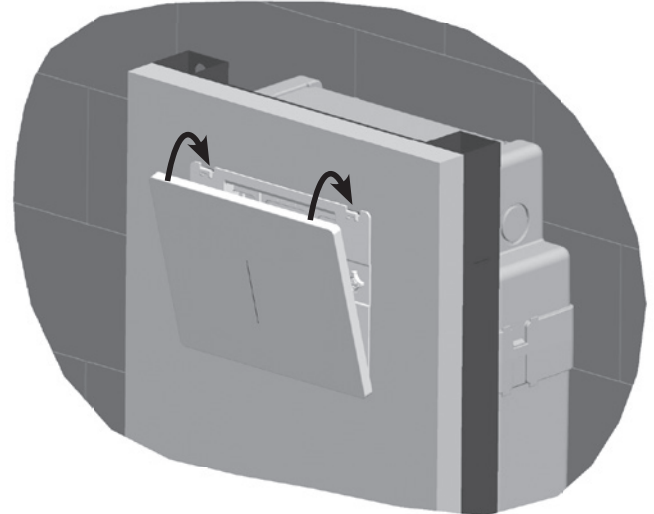



SIAMP
Monaco

4, quai Antoine 1er - BP 219 - MC 98007 MONACO Cedex
Fax : +377 92 05 71 04 - contact@siamp.com - www.siamp.com

10 0059 14